

Übersicht Kellergeschoss

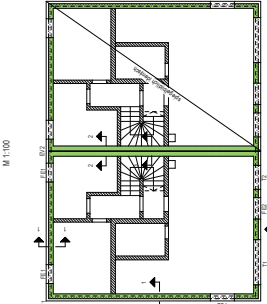

Schnitt 1-1

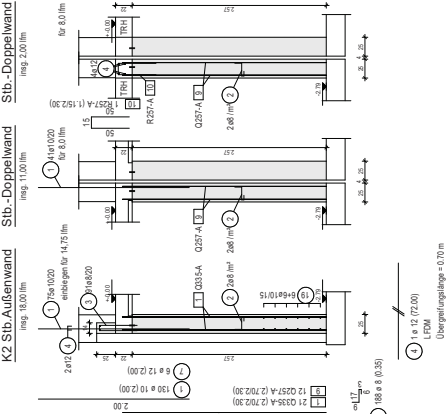

Schnitt 2-2

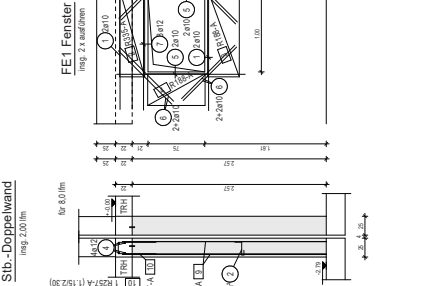

Schnitt 3-3

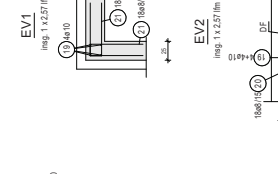
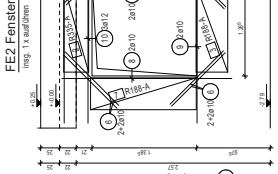
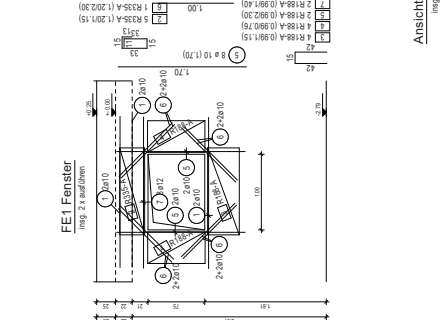

ANSICHT (T+T+FEZ)



SCHNEIDERSKIZZE

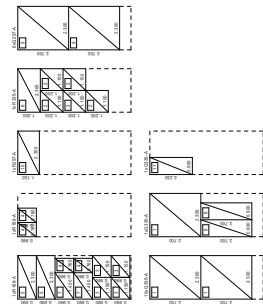

Table with 2 columns: Material, and 2 rows: 1, 2, 3, 4, 5, 6, 7, 8, 9, 10, 11, 12, 13, 14, 15, 16, 17, 18, 19, 20, 21, 22, 23, 24, 25, 26, 27, 28, 29, 30, 31, 32, 33, 34, 35, 36, 37, 38, 39, 40, 41, 42, 43, 44, 45, 46, 47, 48, 49, 50, 51, 52, 53, 54, 55, 56, 57, 58, 59, 60, 61, 62, 63, 64, 65, 66, 67, 68, 69, 70, 71, 72, 73, 74, 75, 76, 77, 78, 79, 80, 81, 82, 83, 84, 85, 86, 87, 88, 89, 90, 91, 92, 93, 94, 95, 96, 97, 98, 99, 100.

Table with 4 columns: POS., STÜCK, SCHMITTLÄNGE, GEWICHT, GEWICHTSLÄNGE. Lists 24 items with their respective quantities, lengths, and weights.

MATTELISTE

Table with 4 columns: POS., STÜCK, TYP, LÄNGE, BREITE, GEWICHT. Lists 10 items with their respective quantities, types, lengths, widths, and weights.

RUNDSTAHL-STÜCKLISTE B 800 AB

2 x ausführen

Technical notes and specifications for the reinforcement, including details for Abstell- bzw. Sollstöße and Abstell-Fuge.

Technical drawing legend and material specifications, including a table for material properties and a table for reinforcement details.

Project information and contact details for Klaus Mairhofer Ingenieurbüro, including address and phone number.